



## YTA 187W YÜKSEK TAVAN AYDINLATMA ARMATÜRÜ



Sipariş Kodu :  
Ürün Kodu : E YTA 187U 40PD00 90 24K6 1042 65

### Ürün Bilgisi

Gövde	: Alüminyum Ekstrüzyon Gövde
Difüzör	: Mikroprizmatik Difüzör Temperli Cam
Kullanım Şekli	: Sıva Üstü Yüksek Tavan Aydınlatma
Işık Kaynağı	: LED
Tüketim Gücü	: 187W
Armatür Lümeni	: 24.684 Lm
Armatür Verimliliği	: 132Lm/W
Giriş Gerilimi	: 220-240 V AC
Çalışma Sıcaklığı	: (-25 °C/+45 °C)
İp Koruma Sınıfı	: IP65
Darbe Dayanım Sınıfı (IK)	: IK08
Led Ömrü L70	: L70 : 157.000 h @Ta= 45°C
Güç Faktörü	: > 0,9
Max. Gerilim Dayanımı (Surge)	: 1/4 Kv
Sürüş Akımı	:
Renksel Geriverim İndeksi (CRI)	: 80
Renk Sıcaklığı (CCT)	: 4000K
Standartlar	: EN60598-1 standartlarına uygun
Gövde Rengi	: Antrasit Gri RAL7016
Fotobiyolojik Güvenlik Grubu	: RG1
Teknik Değerlerde $\pm$ %10 Tolerans Vardır.	

### Fotometrik Eğri

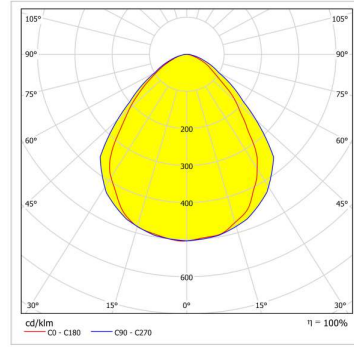

### Opsiyonel Özellikler

Sensör Uyumluluğu	: Yok
ACK Uyumluluğu	: Opsiyonel
Dali Uyumluluğu	: Opsiyonel
Renk Sıcaklığı	: 3000K -5700K-6500K

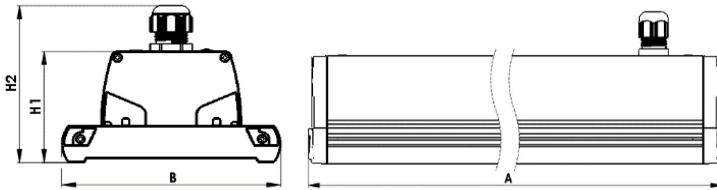

### Uzunluk Ölçüleri (mm)

	A	B	H1	H2
Standard	: 1042	140	75	105
Dali	: 1042	140	75	105
1-3 Saat ACK	: 1042	140	75	105

### Ağırlık (kg)

Standard	: 4,7
Dali	: 4,7
1-3 Saat ACK	: 4,85

## ASKI SİSTEMLERİ

### Tava Askı Takımı

E YTA TAVA ASKI TK

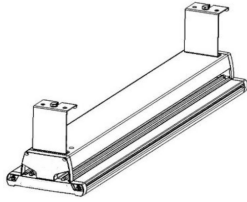
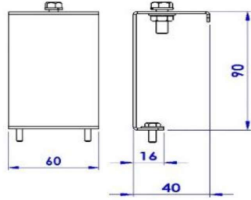

### Bara Askı Takımı

E YTA BARA ASKI TK

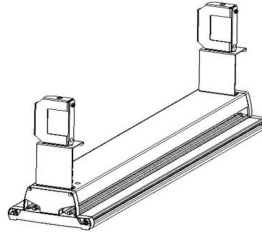
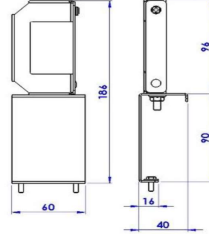

### Dereceli Askı Takımı

E YTA DERECELİ ASKI TK

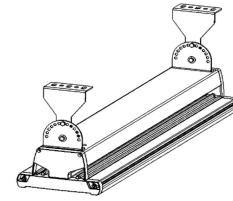
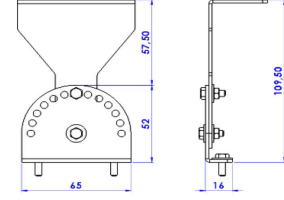

### İkili Bara Askı Takımı = E YTA İKİLİ BARA ASKI TK

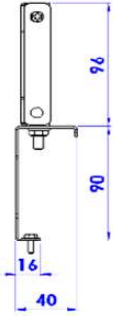
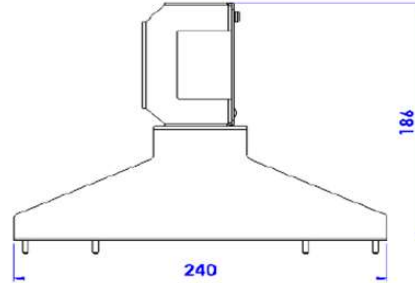
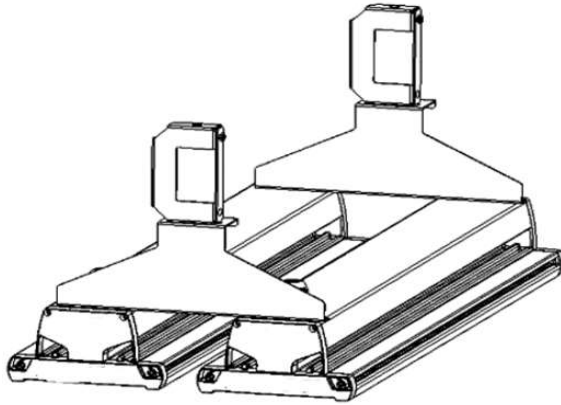

### İkili Tava Askı Takımı = E YTA İKİLİ TAVA ASKI TK

